

Technische Information

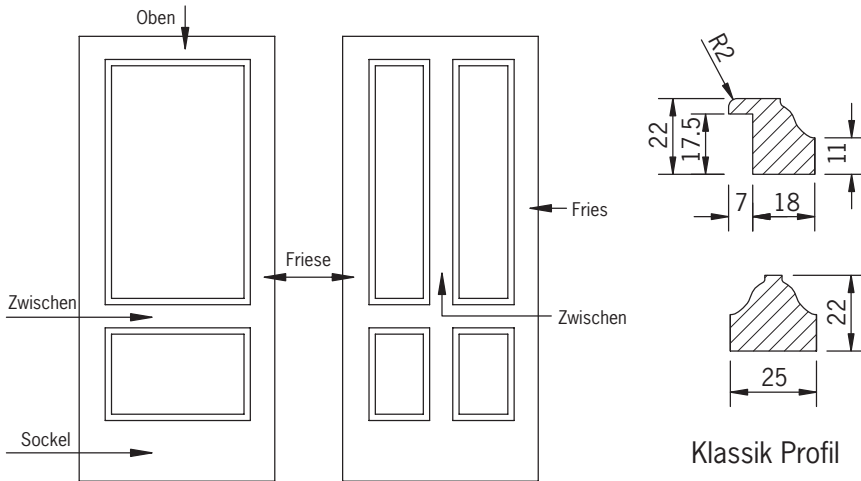

Ambiente Basic
Formgespresste Stilltüren

Friesbreiten/Zwischen- und Sockelmasse, Angaben in mm.
Fertigungsbedingt können diese Masse +/- 3 mm Abweicher.

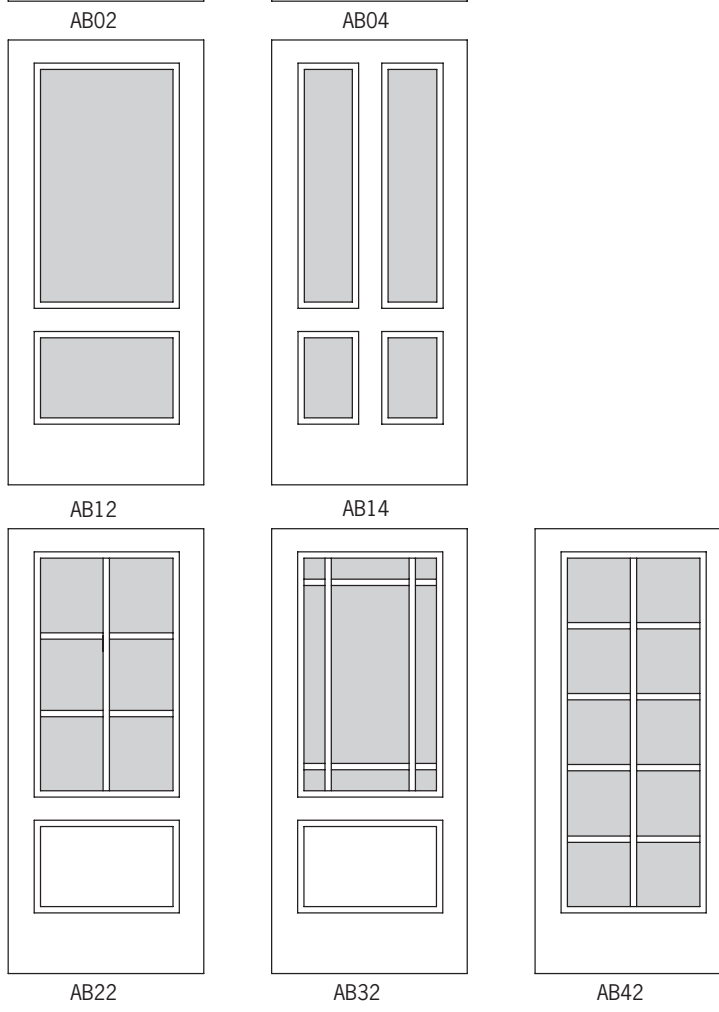

	Oben	Zwischen	Sockel
1985			
AB02	117	120	142
AB04	95	173	179
AB12-AB22-AB32	108	111	142
AB14	84	162	179
AB42	108		133
	Oben	Zwischen	Sockel
2110			
AB02	154	120	230
AB12-AB22-AB32	148	108	230
AB42	148		218
	Friese	Zwischen	
610			
AB02	117,5		
AB04	107	98	
AB12-AB22	108,5		
AB14	98,5	81	
AB42	108,5		
	Friese	Zwischen	
735			
AB02	130		
AB04	119	98	
AB12-AB22-AB32	121	108	
AB14	110,75	81,5	
AB42	121		
	Friese	Zwischen	
860			
AB02	142,5		
AB04	130	98	
AB12-AB22-AB32	133,5		
AB14	122,5	83	
AB42	133,5		
	Friese	Zwischen	
985			
AB02	155		
AB04	142	98	
AB12-AB22-AB32	146		
AB14	134,25	82,5	
AB42	146		



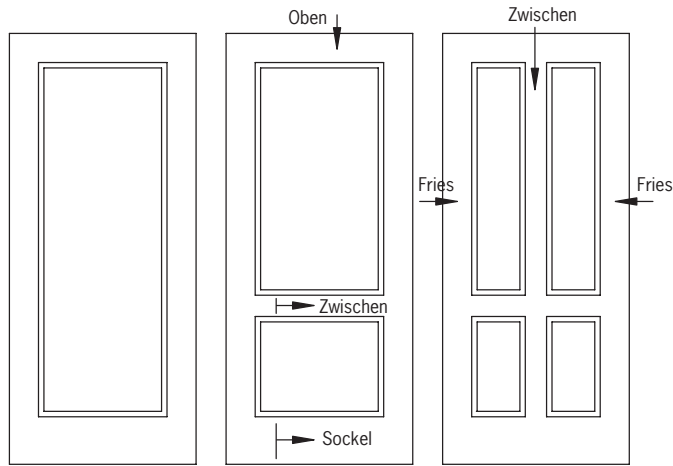

A001

A002

A003

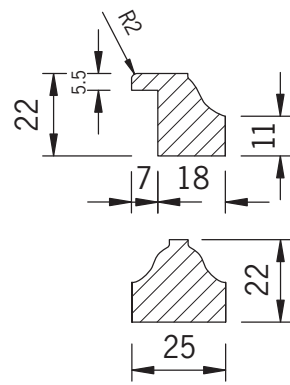

Klassik Profil

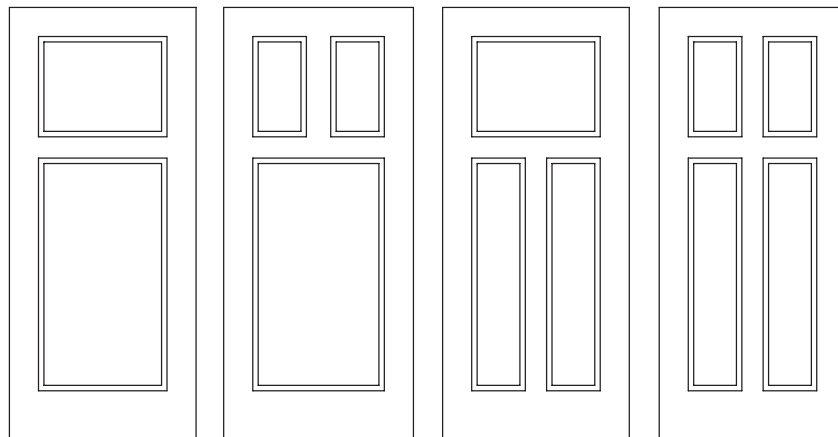

A004

A005

A006

A007

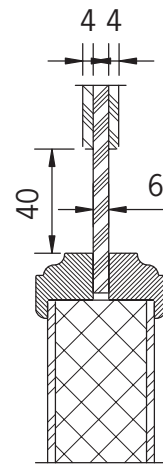

mit aufgedoppelter Füllung

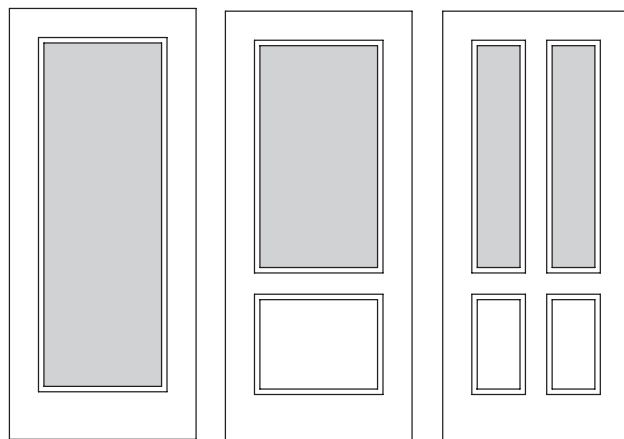

A011

A012

A013

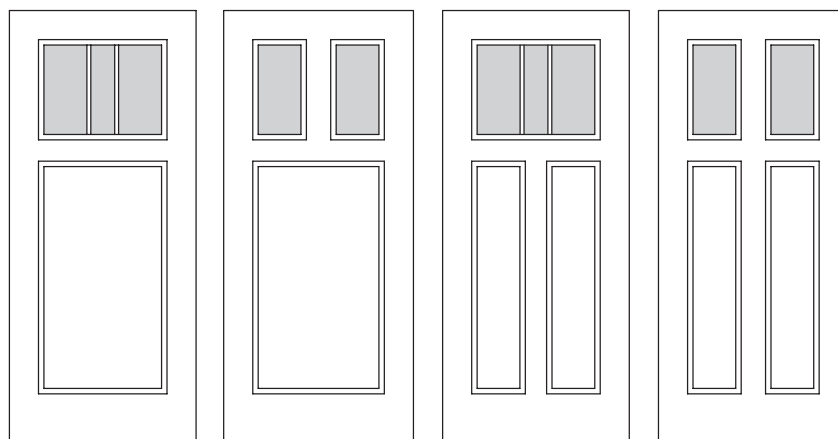

A014

A015

A016

A017

Ambiente Old Dutch

EPC Superlack Stilltüren, mit Füllung aus MDF.

Alle Angaben in mm und nur gültig für Standardabmessungen. Bei Abweichende Masse können die Masse und der Optik abweichen.

	Oben	Zwischen	Sockel
1985			
A001-A011	134		219
AO überige Modelle	134	98	219
	Oben	Zwischen	Sockel
2110			
A001-A011	134		219
AO überige Modelle	134	98	219
	Friese	Zwischen	
735/860/985			
A001-A011	134		
AO überige Modelle	134		
LA Gross			
AO überige Modelle	134	98	
LA Schmall			

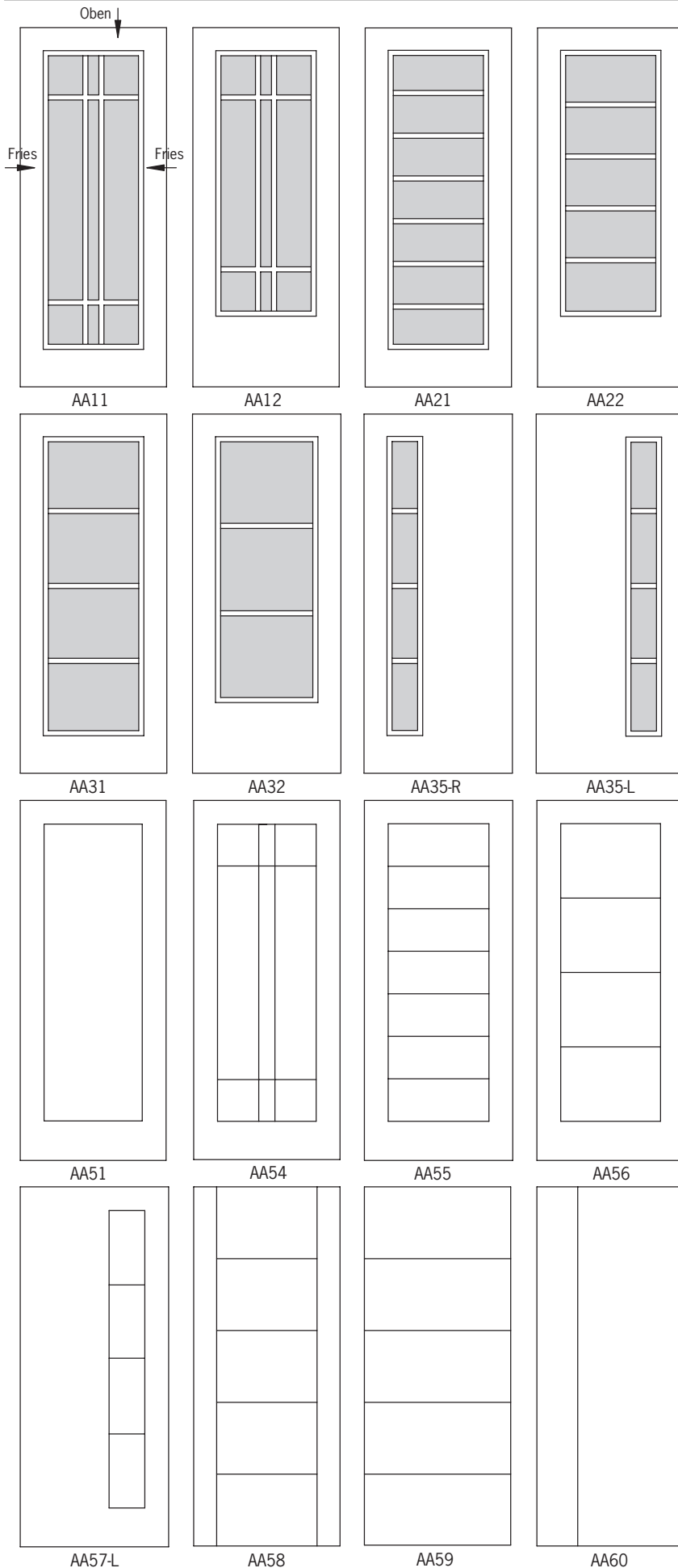

Ambiente Art Deco

EPC Superlack Türen mit Sprossenrahmen, moderne Profil oder mit Linienfräsung in gleicher Optik wie die Sprossenrahmen.

Alle Angaben in mm und nur gültig für Standardabmessungen. Bei Abweichende Masse können die Masse und der Optik abweichen.

	Oben	Sockel
1985		
AA11-AA21-AA31-AA35	135	220
AA12-AA22-AA32	135	219
	Oben	Sockel
2110		
AA11-AA21-AA31-AA35	135	220
AA12-AA22-AA32	135	415
	Friese	
610/735/985		
AA11-AA21-AA31-AA35	135	
AA12-AA22-AA32	135	

Hinweis bei AA21 aus der Schlossseite bei AA22 aus der Bandseite

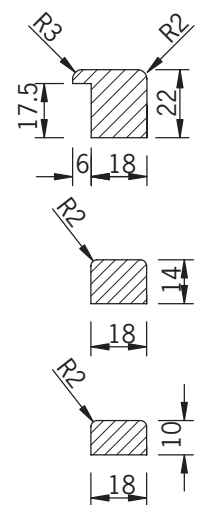

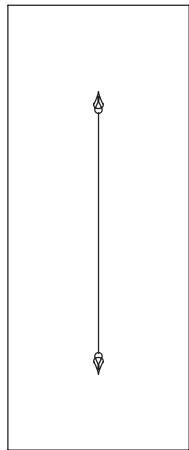

AV41

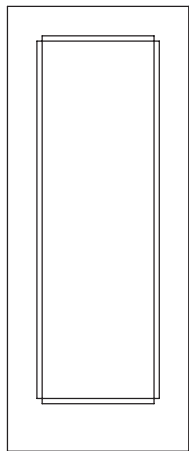
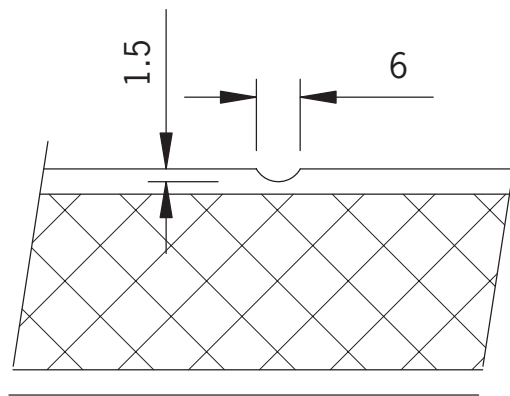

AV61

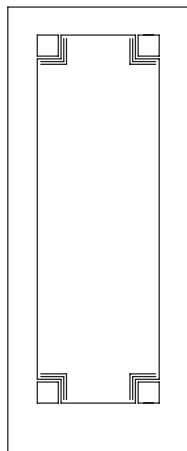

AV62

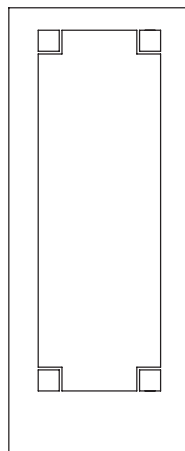

AV63

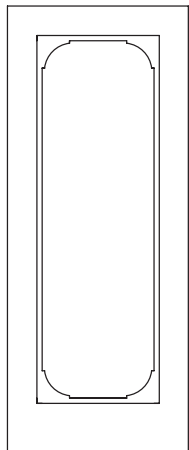

AV64

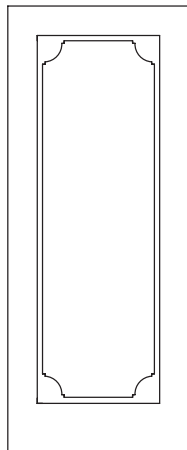

AV65

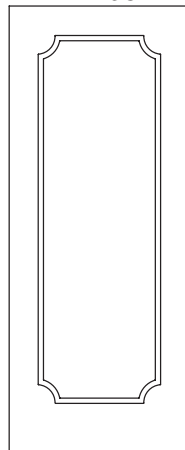

AV66

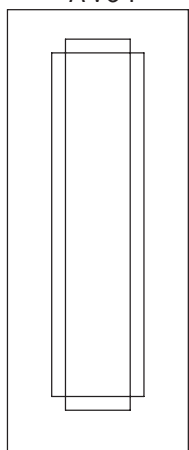

AV91

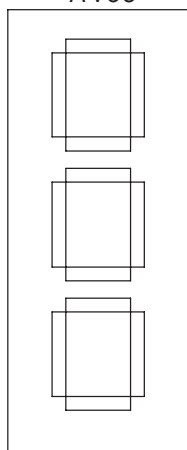

AV92

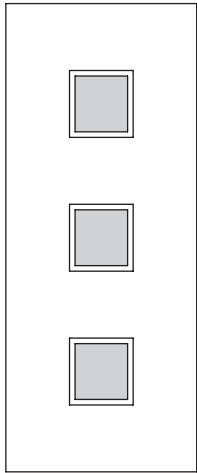

AL31

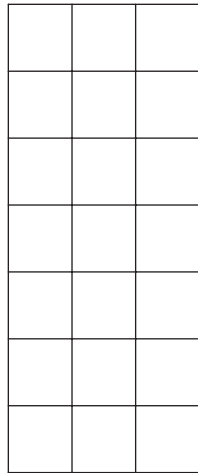

AL76

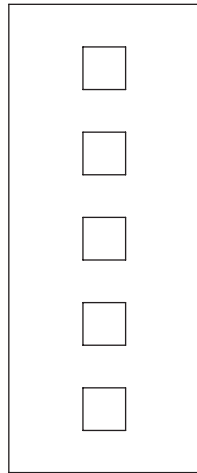

AL77

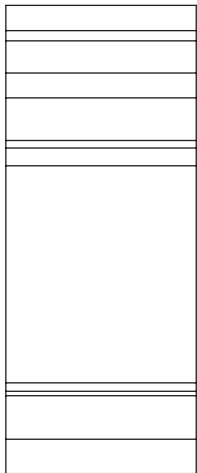

AL81

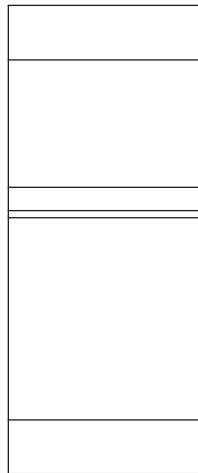

AL82

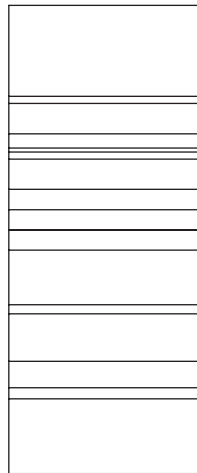

AL83

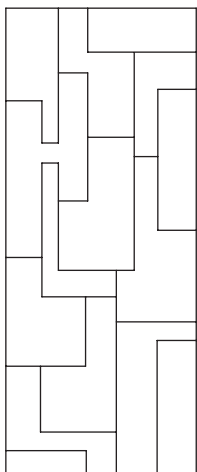

AL91

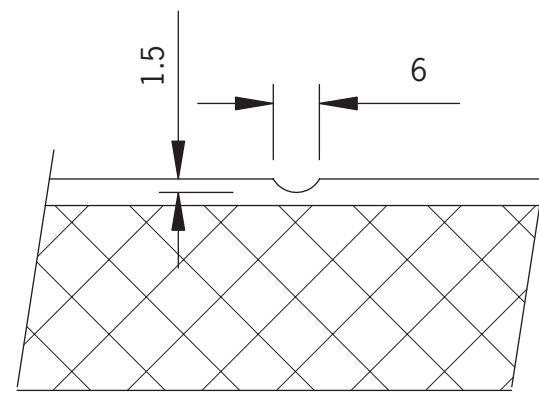

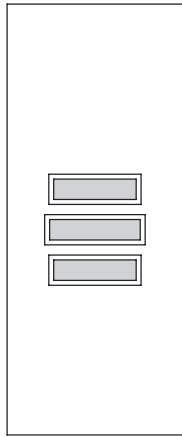

AE03

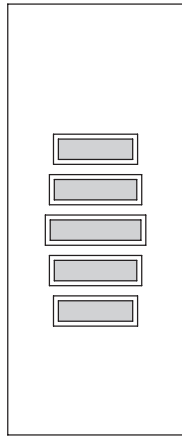

AE05

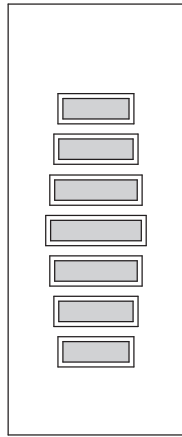

AE07

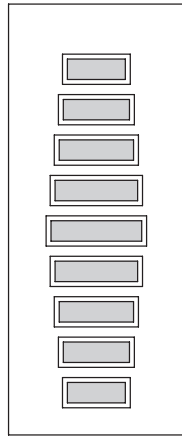

AE09

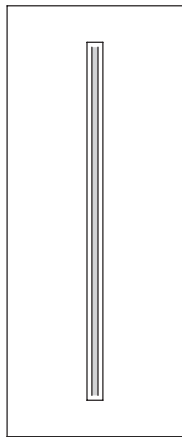
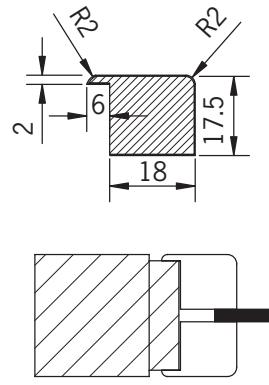

AE11

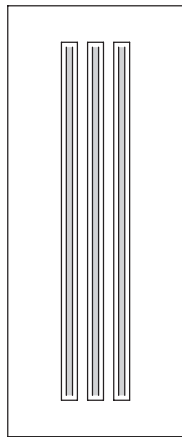

AE13

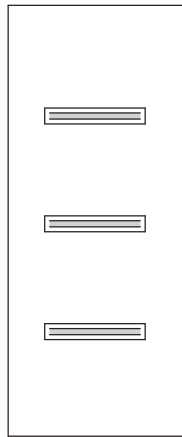

AE16

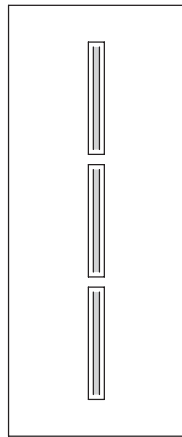

AE113

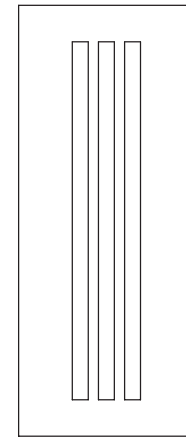

AE53

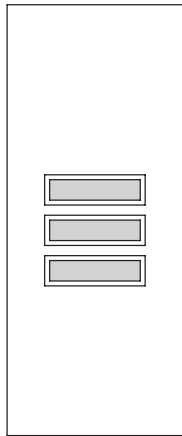

AE23

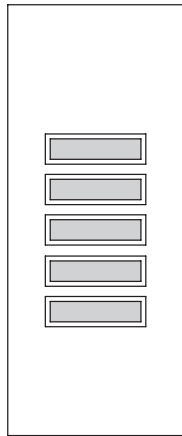

AE25

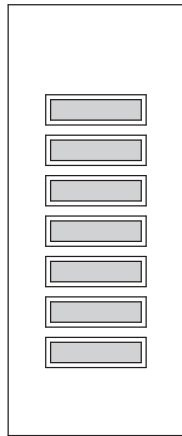

AE27

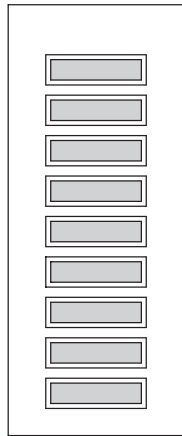

AE29

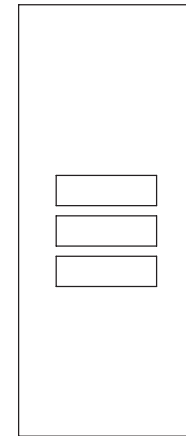

AE63

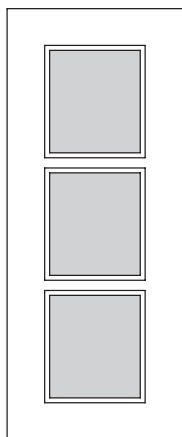

AE33

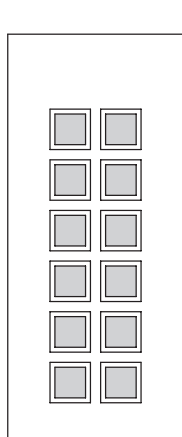

AE34
Türhöhe 1985

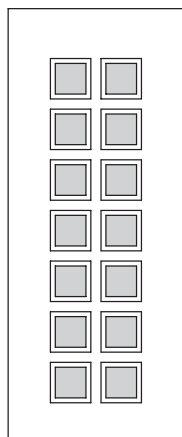

AE34
Türhöhe 2110

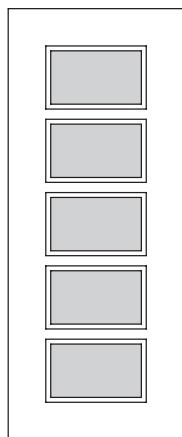

AE35

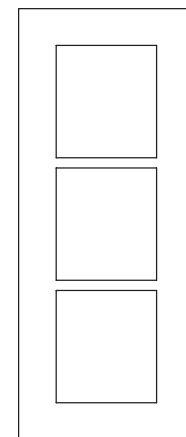

AE73

Ambiente Elite

EPC Superlack Designtüren mit Lichtausschnitte und flächenbündige Glasleisten.

Alle Angaben in mm und nur gültig für Standardabmessungen. Bei Abweichende Masse können die Masse und der Optik abweichen.

	Oben	Zwischen	Sockel
1985			
AE03	703	52	734
AE05	503	52	534
AE07	303	52	334
AE09	103	52	134
AE11-AE13	178,5		178,5
AE16	373	452	474
AE23	703	52	734
AE25	503	52	534
AE27	303	52	334
AE29	103	52	134
AE33	178,5	52	178,5
AE34	356	52	181
AE113	178,5	52	178,5
	Oben	Zwischen	Sockel
2110			
AE03	828	52	734
AE05	628	52	534
AE07	428	52	334
AE09	228	52	134
AE11-AE13	178,5		178,5
AE16	498	452	474
AE23	828	52	734
AE25	628	52	534
AE27	428	52	334
AE29	228	52	134
AE33	178	52	178
AE34	231	52	181
AE113	178	52	178

	Friese	Zwischen
735		
AE03-AE05-AE07-AE09	184	
AE11	328,5	
AE13	198,5	52
AE16	184	
AE23-AE25-AE27-AE29	184	
AE33	184	
AE34	143,5	52
AE113	328,5	
	Friese	Zwischen
860		
AE03-AE05-AE07-AE09	184	
AE11	391	
AE13	261	52
AE16	184	
AE23-AE25-AE27-AE29	184	
AE33	184	
AE34	206	52
AE113	391	
	Friese	Zwischen
985		
AE03-AE05-AE07-AE09	184	
AE11	453,5	
AE13	323,5	52
AE16	184	
AE23-AE25-AE27-AE29	184	
AE33	184	
AE34	268,5	52
AE113	453,5	

Glasleisten: Höhe 7 mm
Breite 3 mm

Die Lichtöffnungen werden zentriert auf die Tür verteilt. Der mittlere Lichtöffnung liegt um den Schlosskasten zentriert. Zwischenfriese sind alle gleich.

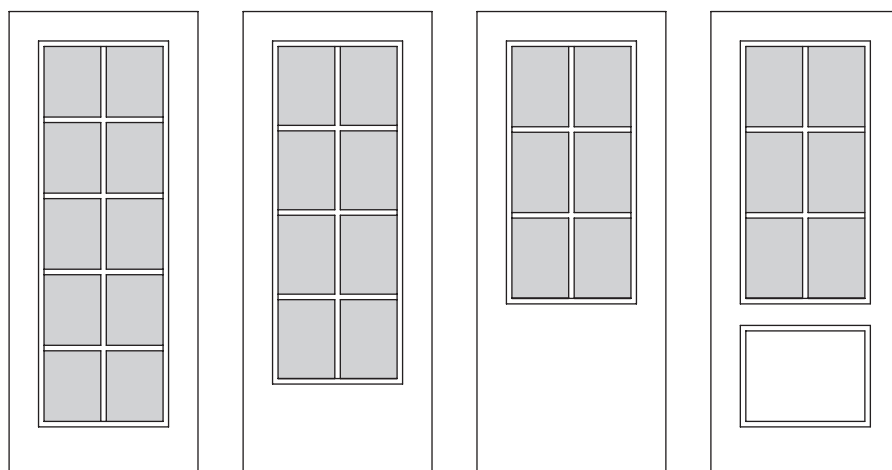

AR11

AR12

AR13

AR14

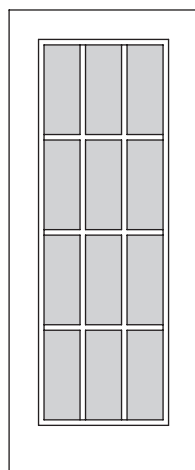

AR21

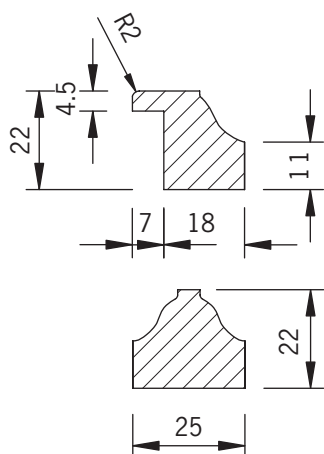

	Oben	Zwischen	Unten
1985			
AA11-AA21-AA31-AA35	135		220
AA12-AA22-AA32	135		415
A001-A011	134		219
AO-overige modellen	134	98	219
AR11-AR21	134		219
AR12	134		414
AR13	134		779
AR14	134	98	219
	Oben	Zwischen	Unten
2110			
AA11-AA21-AA31-AA35	135		220
AA12-AA22-AA32	135		415
A001-A011	134		219
AO-overige modellen	134	98	219
AR11-AR21	134		219
AR12	134		414
AR13	134		779
AR14	134	98	219
	Friese	Zwischen	
735/860/985			
AA11-AA21-AA31-AA35	135		
AA12-AA22-AA32	135		
A001-A011	134		
AO-overige modellen breed frame	134		
AO-overige modellen smal frame	134	98	
AR11-AR21	134		
AR12	134		
AR13	134		
AR14	134		